

3

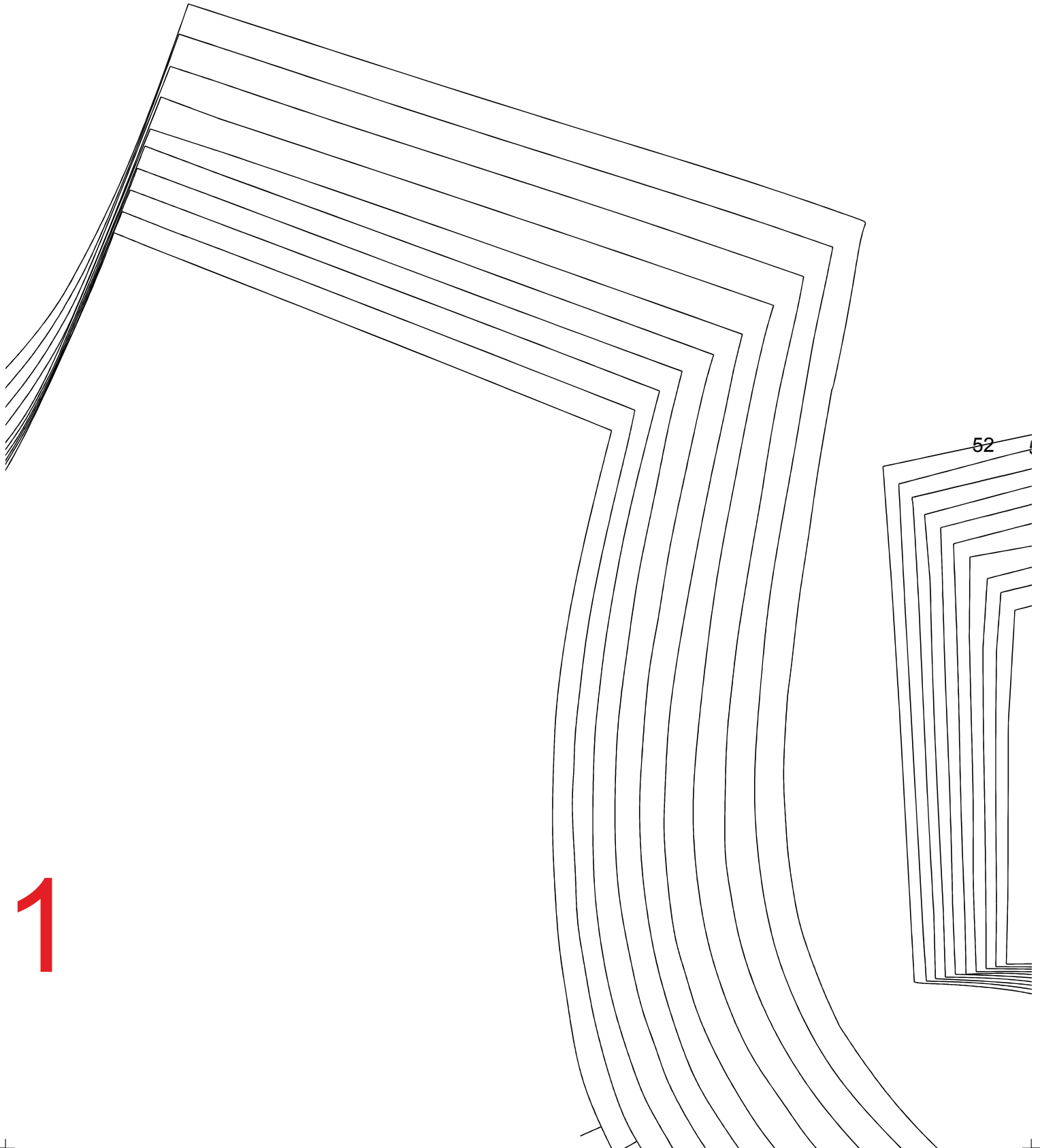

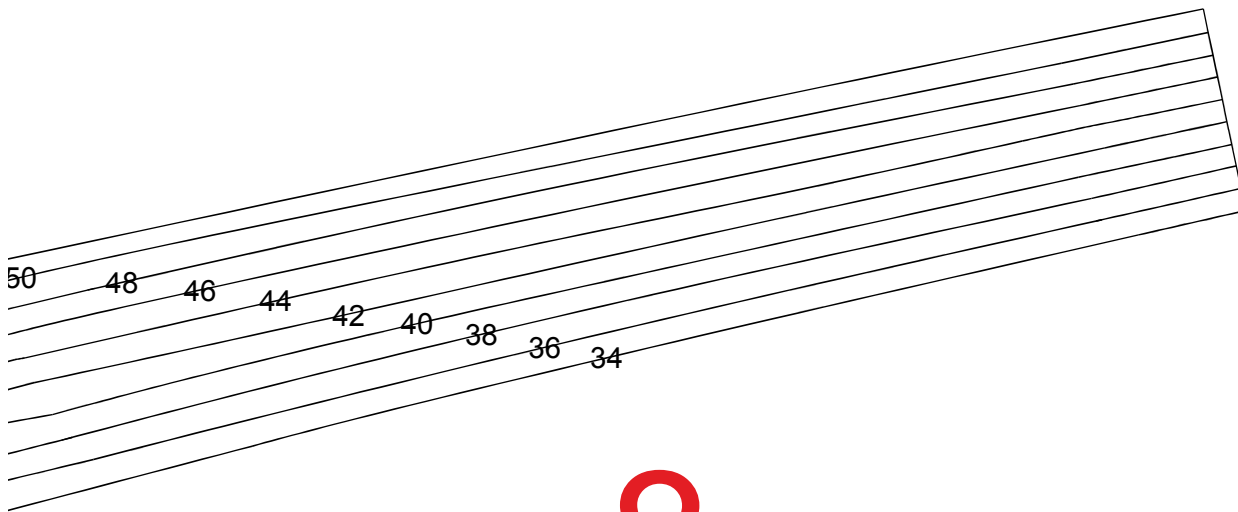

1



8

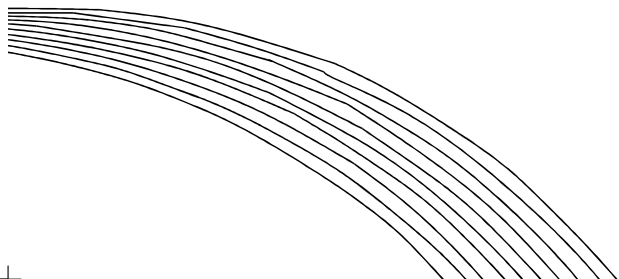
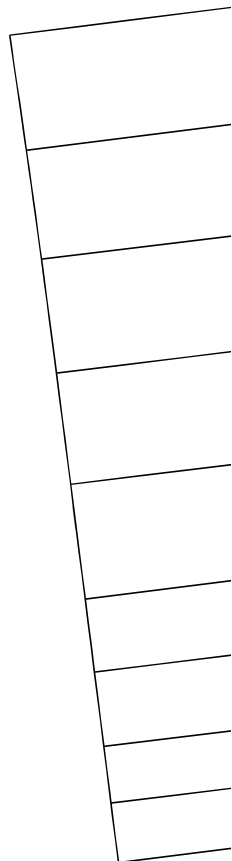

52

50

48

46

44

42

40

38

36

34

2

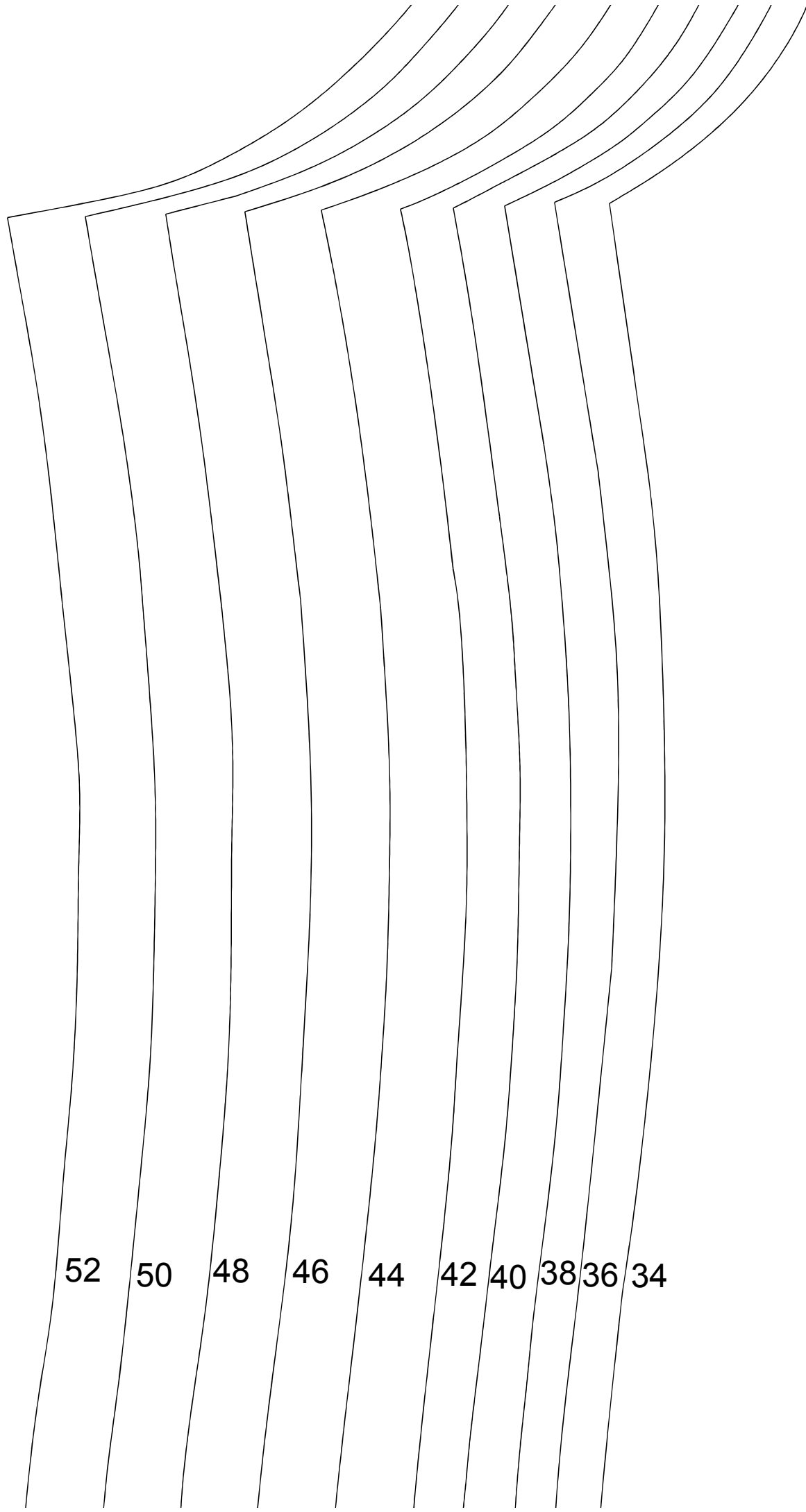

52

50

48

46

44

42

40

38

36

34







(3, 2)

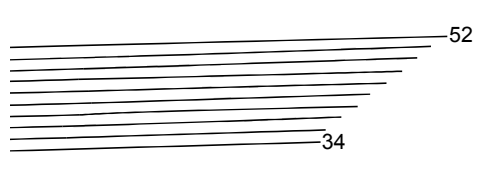
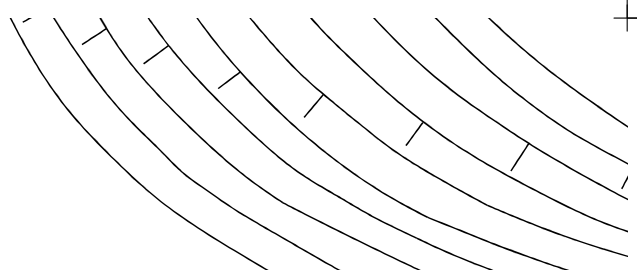

34 36 38 40 42

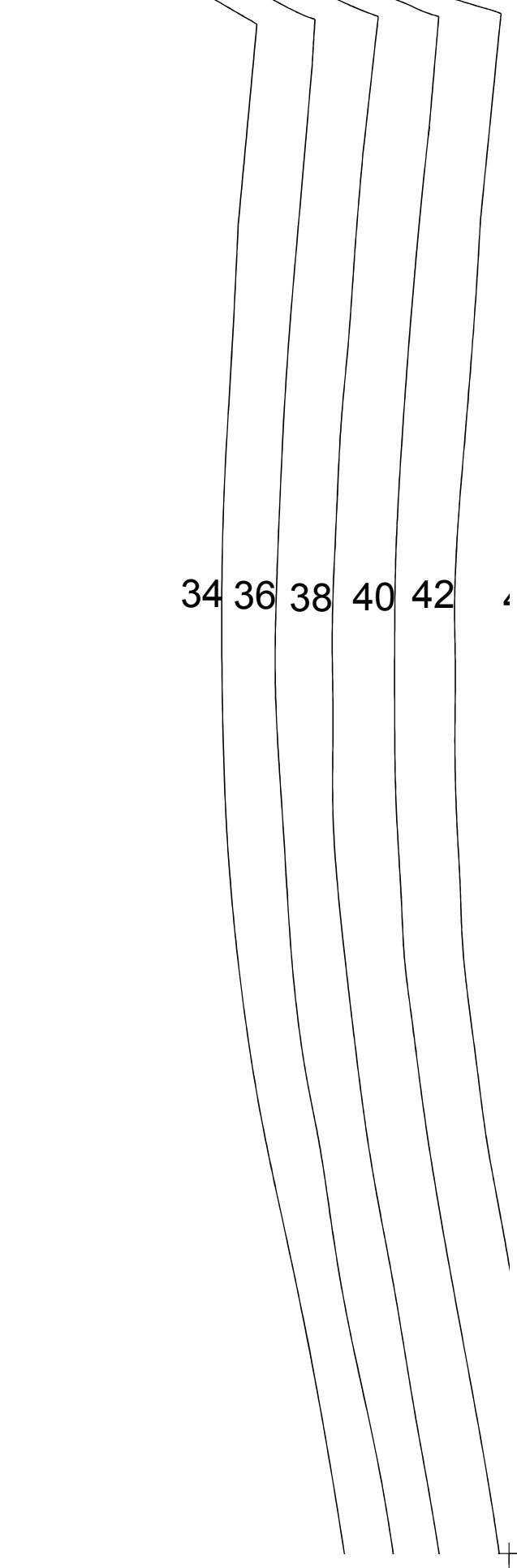

(4, 2)

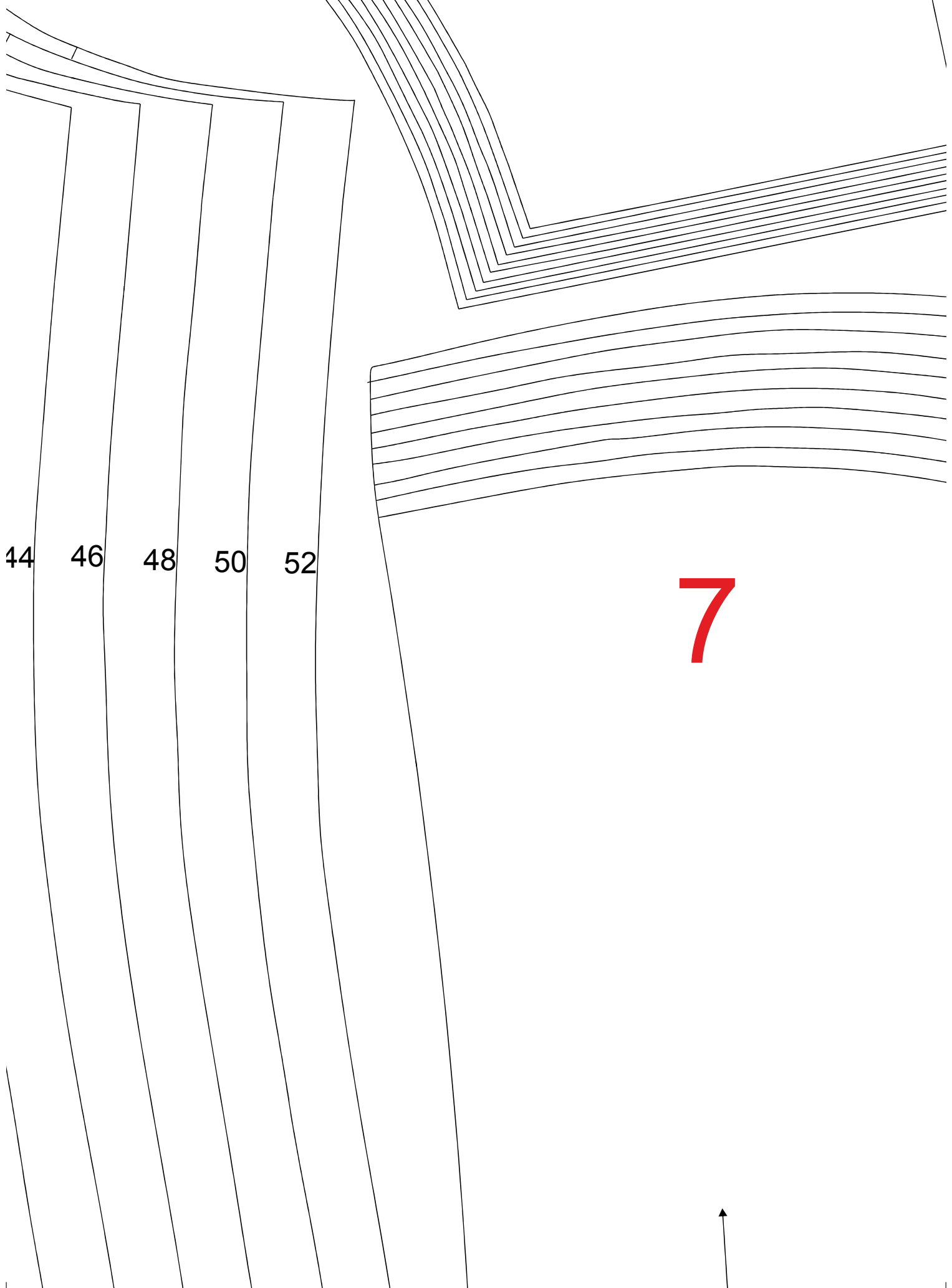

44

46

48

50

52

7

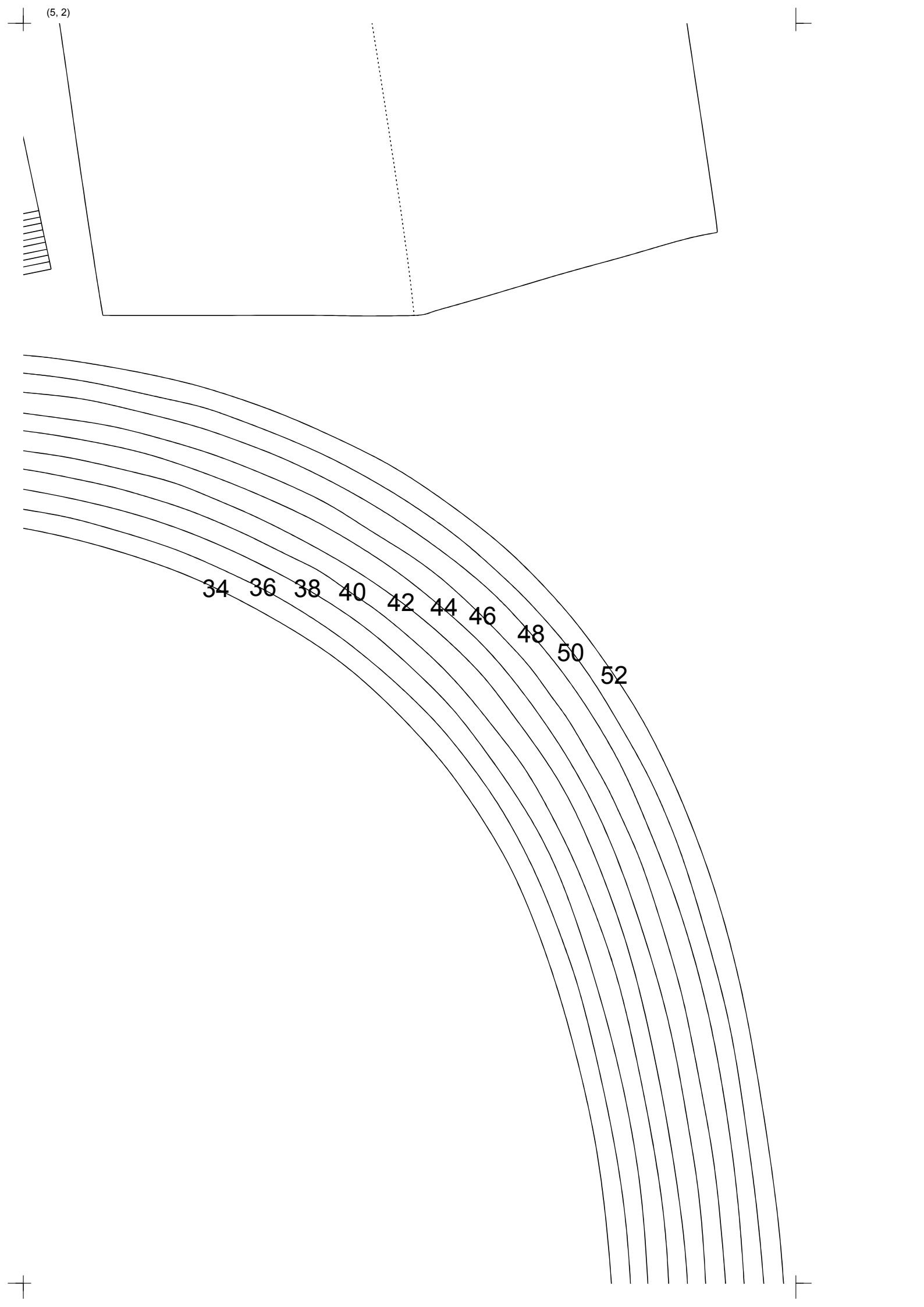

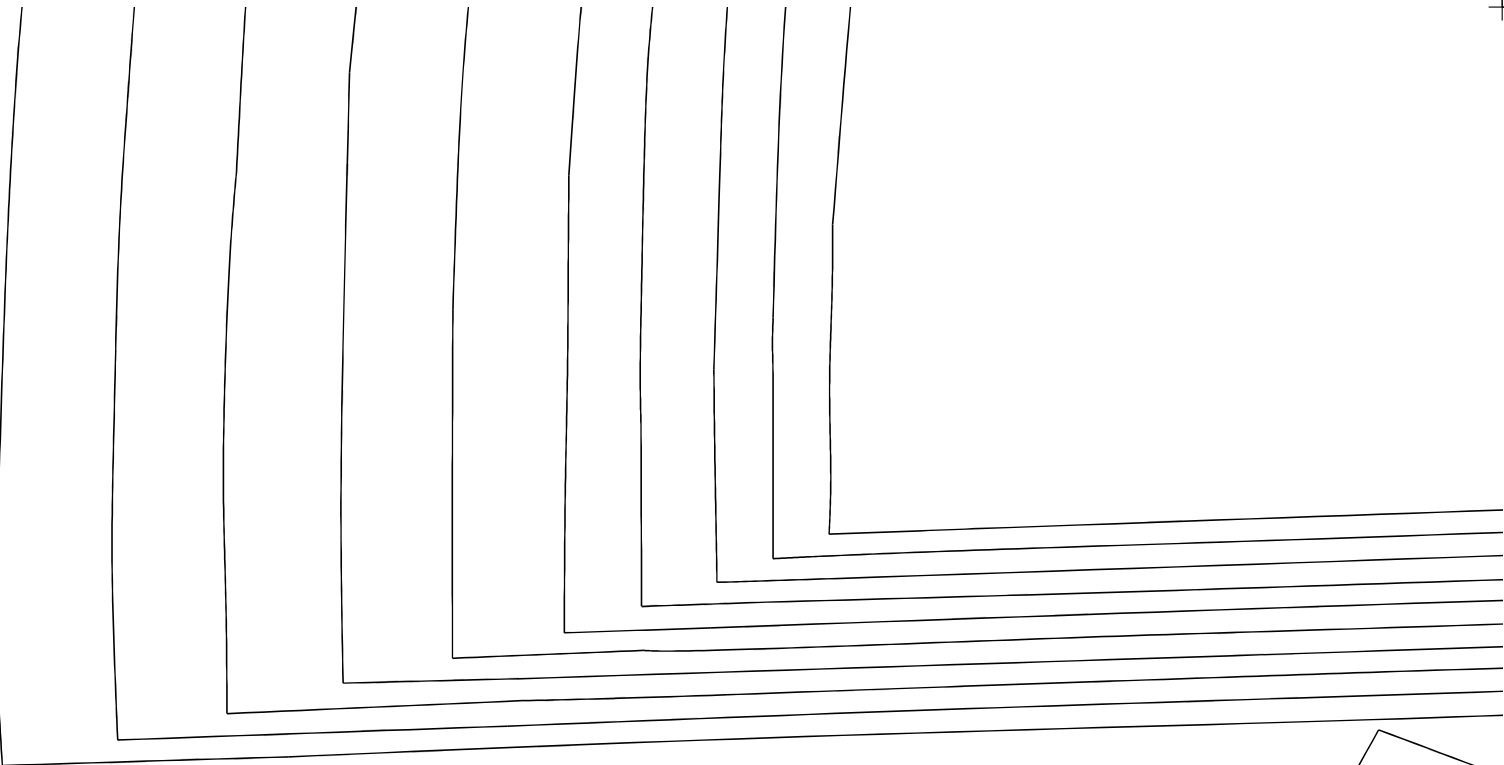

3x3.2

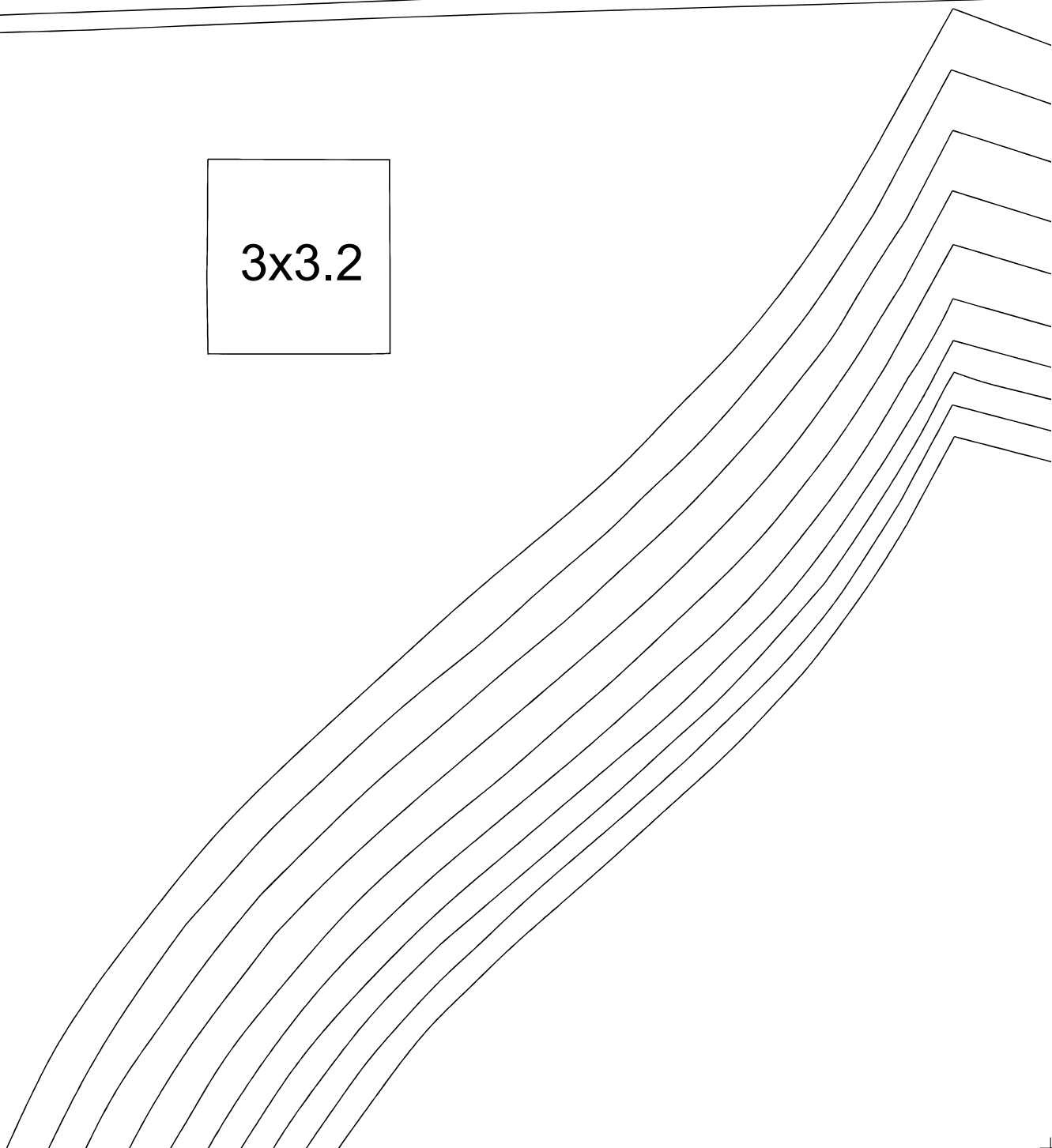

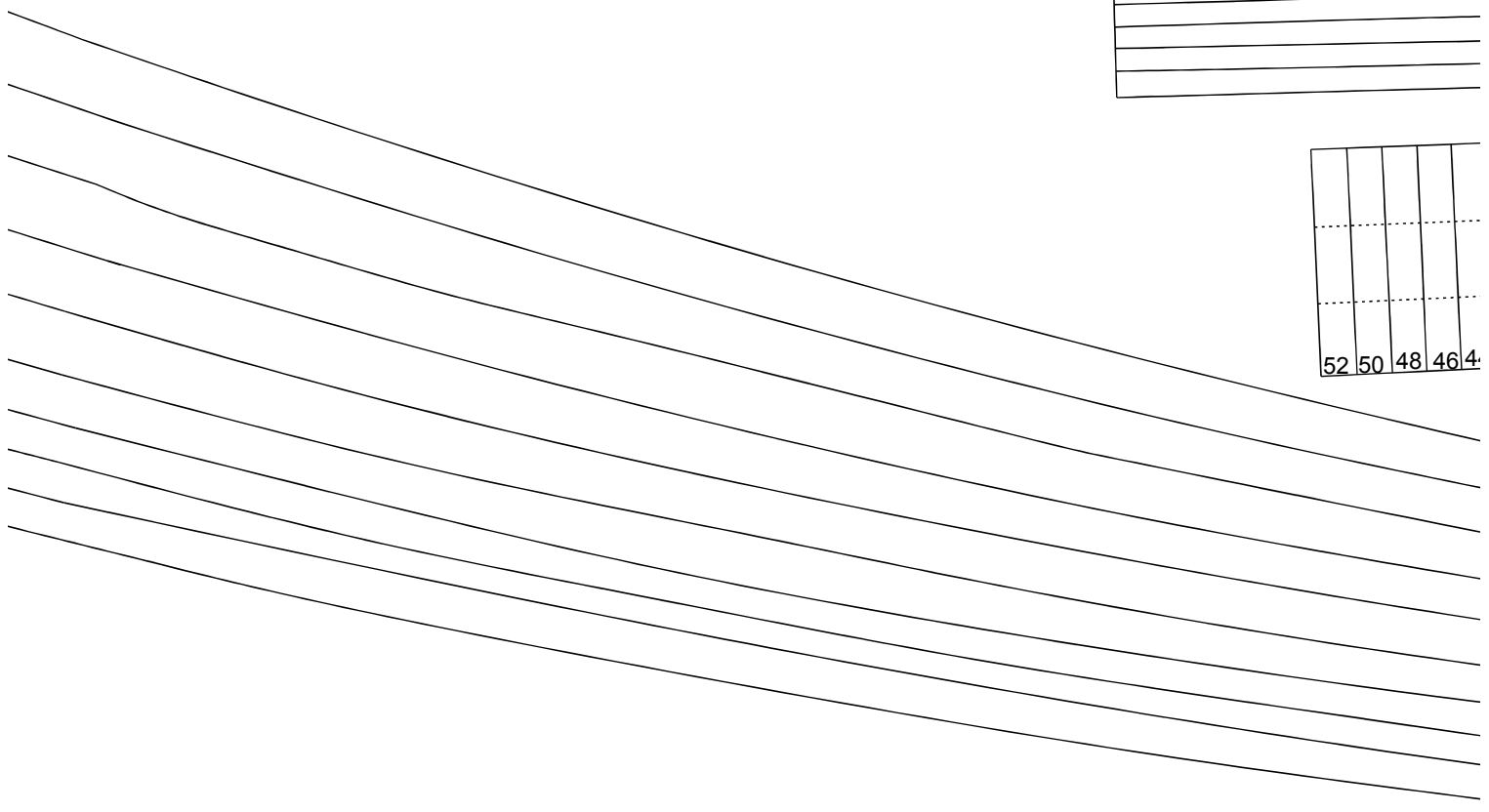
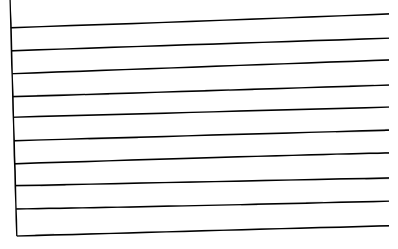
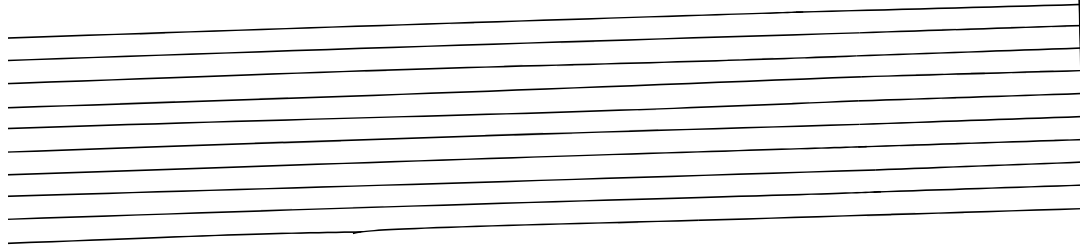

52	50	48	46	44

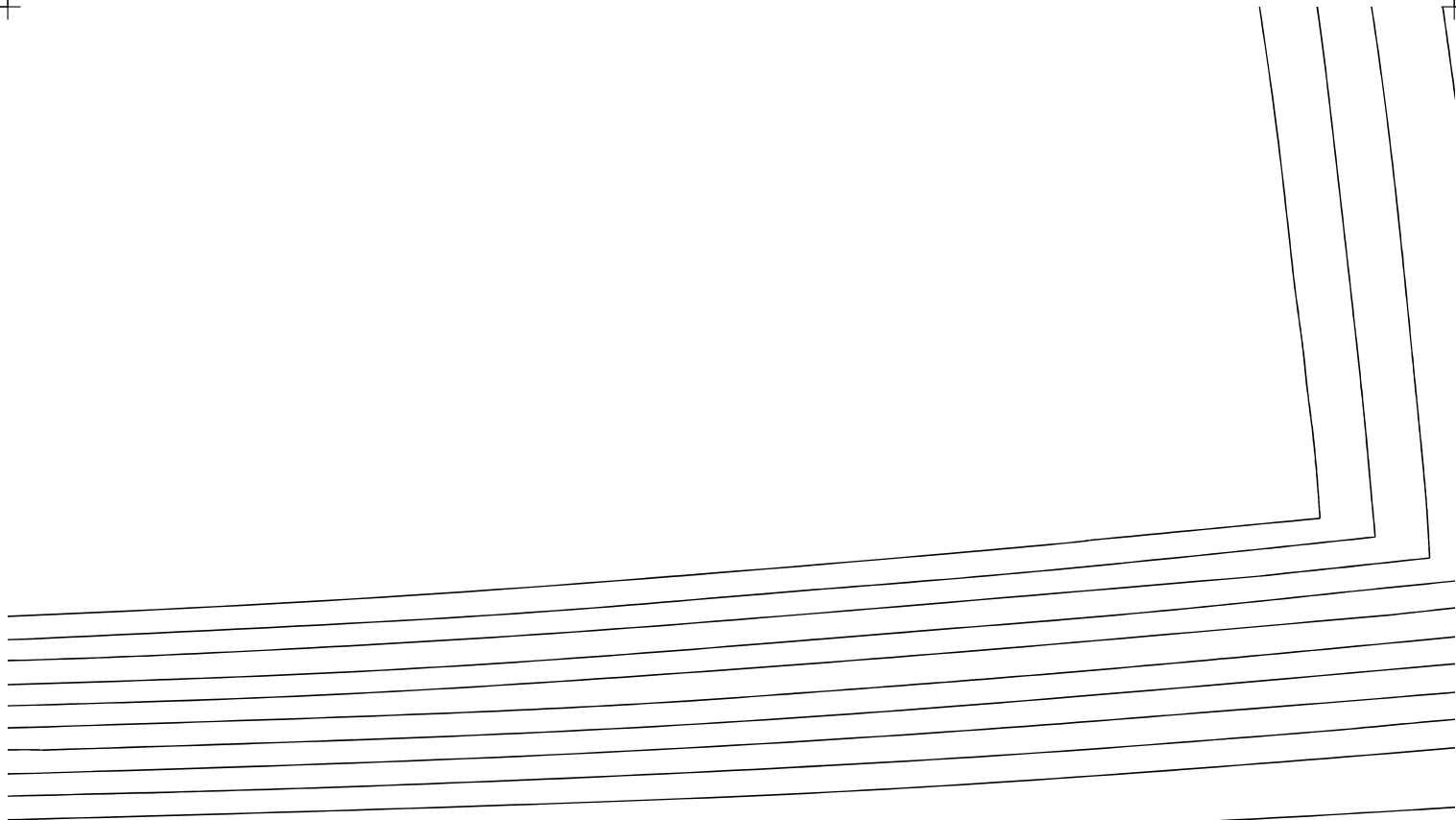

4	42	40	38	36	34
---	----	----	----	----	----

10

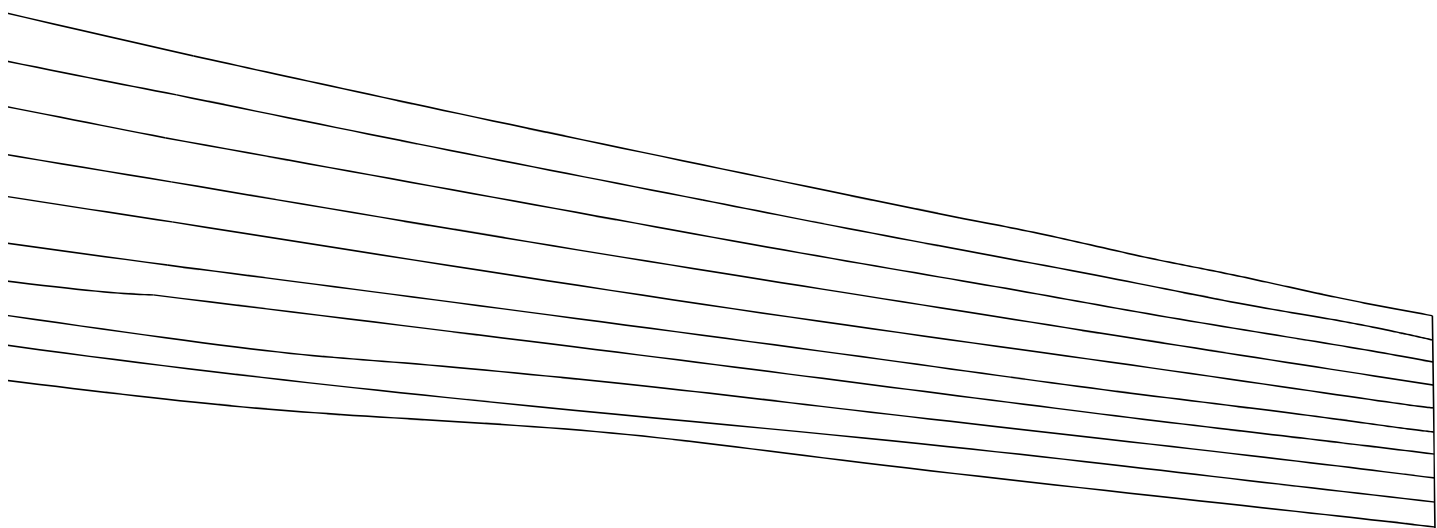

(4, 3)

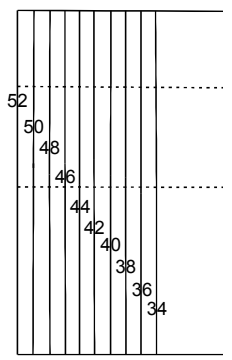
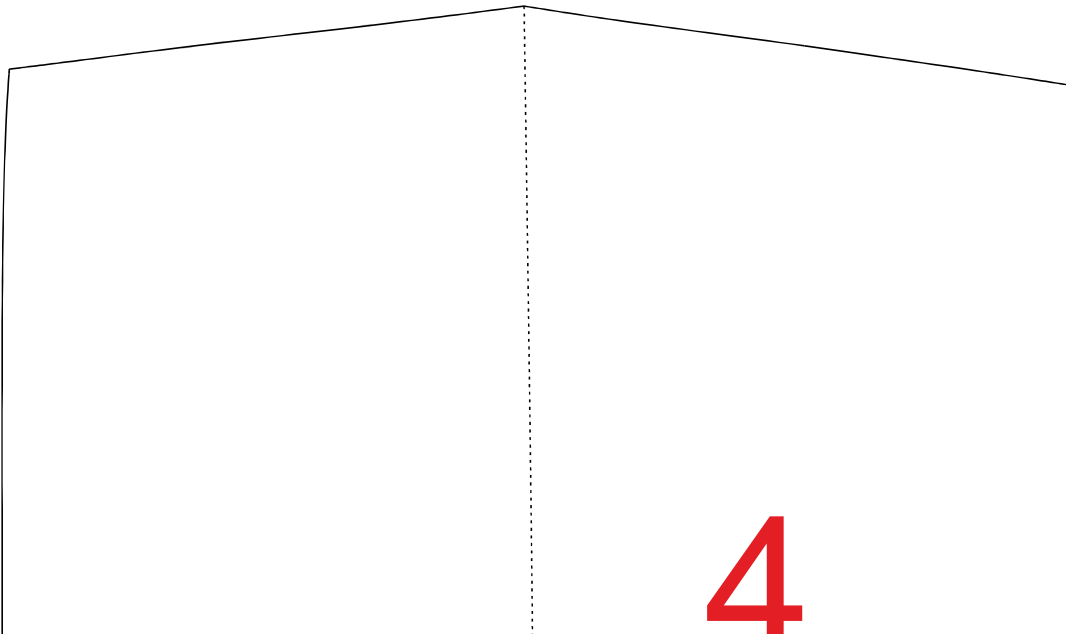
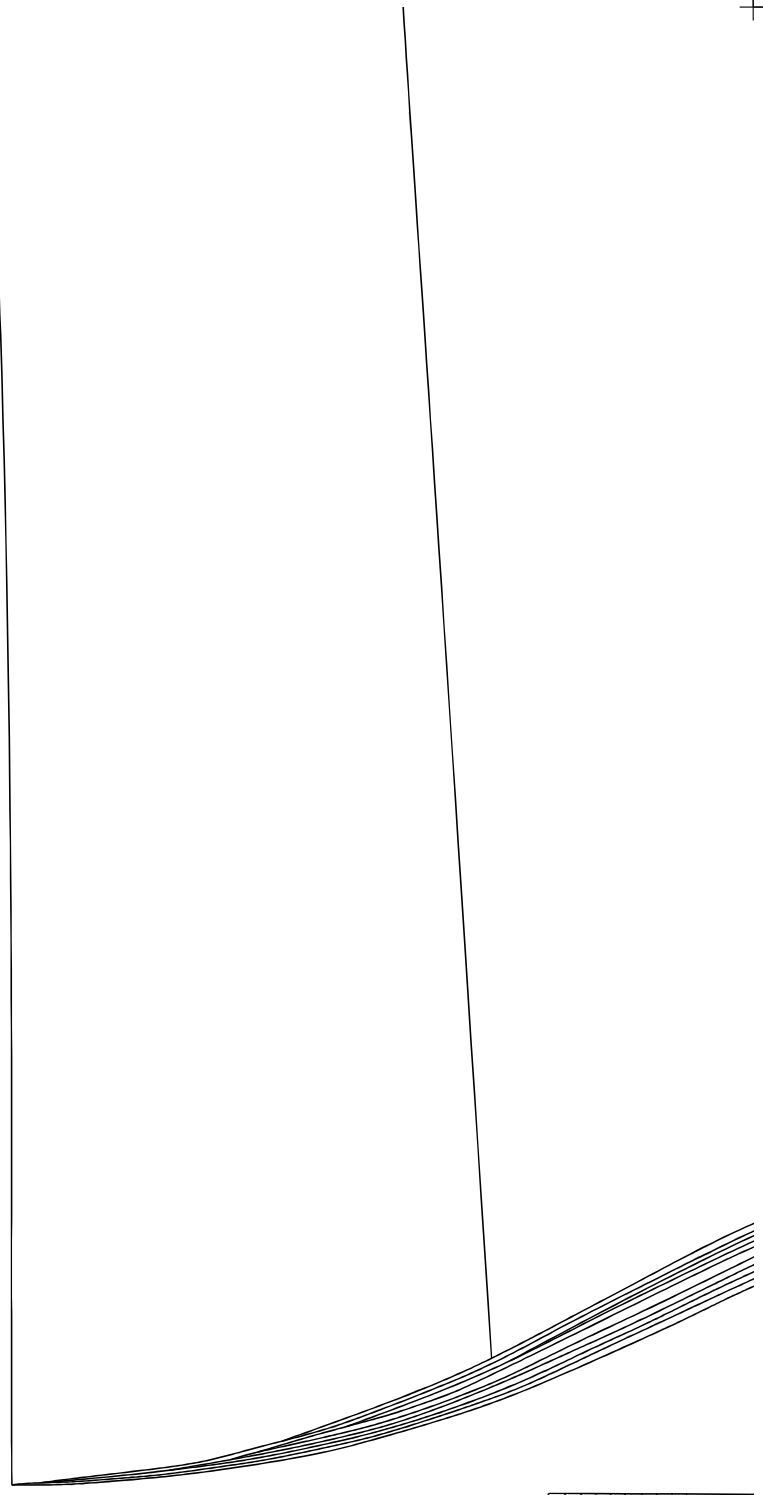
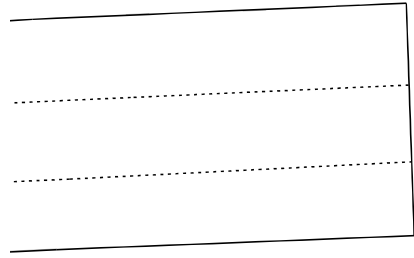
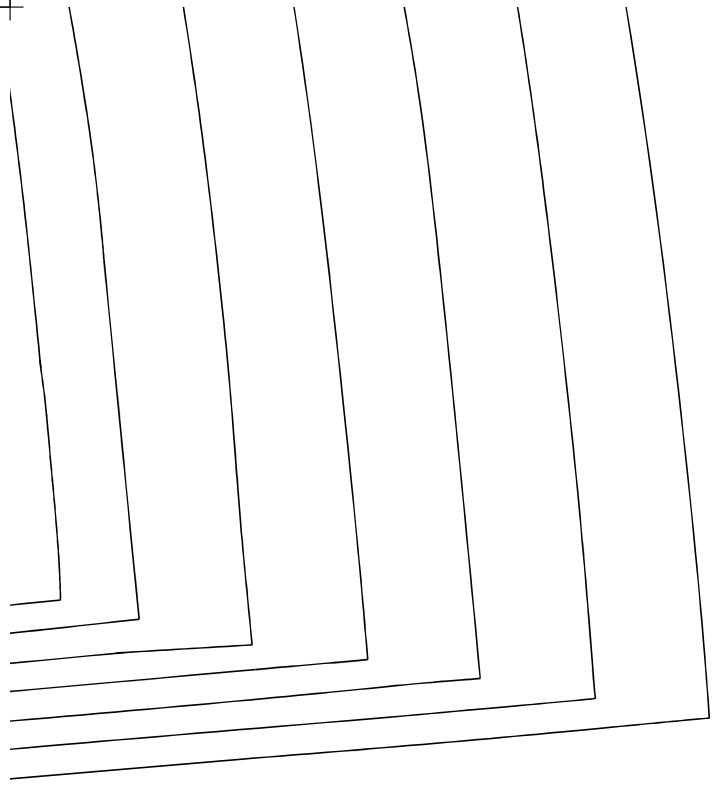

4

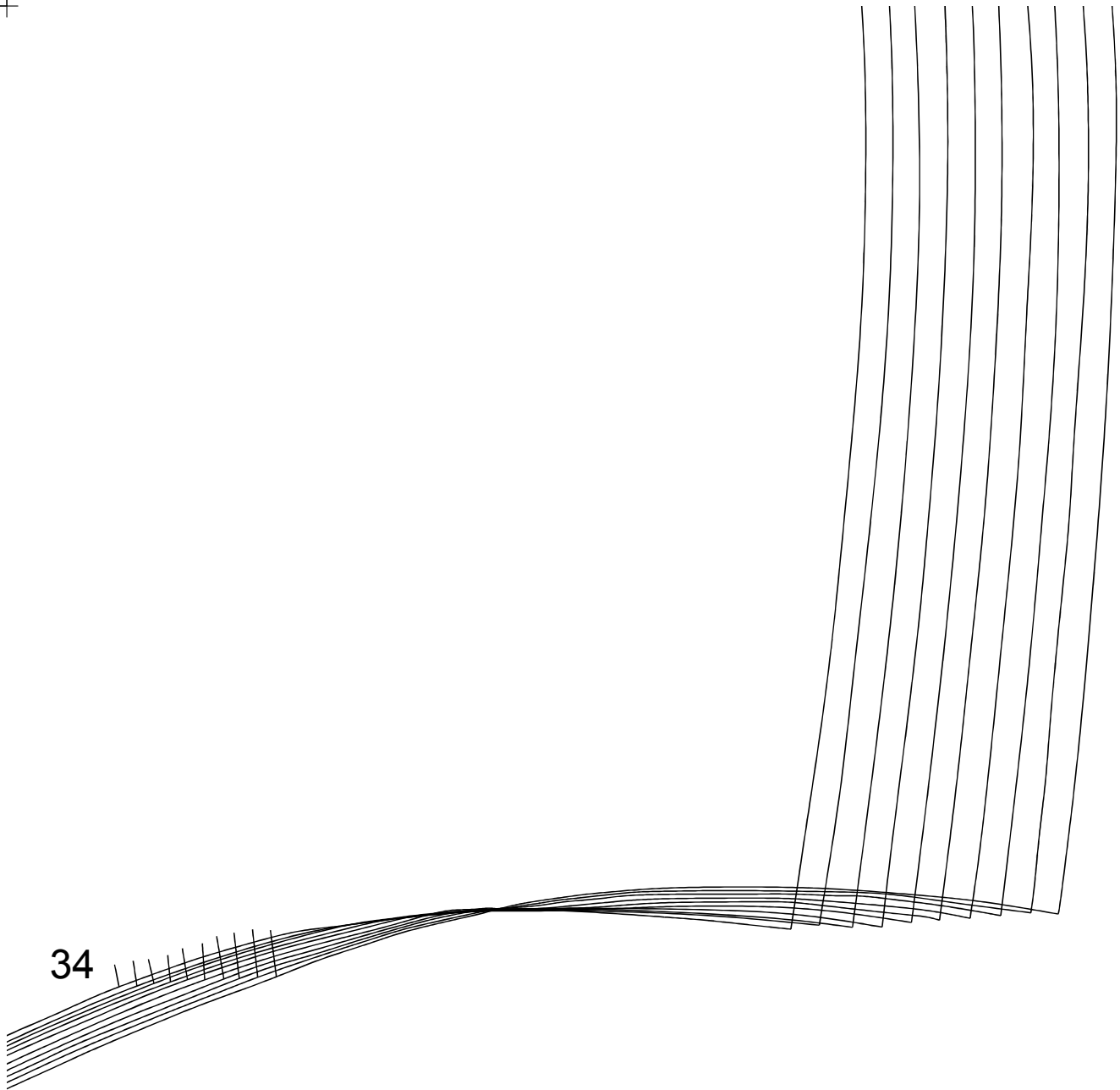

34

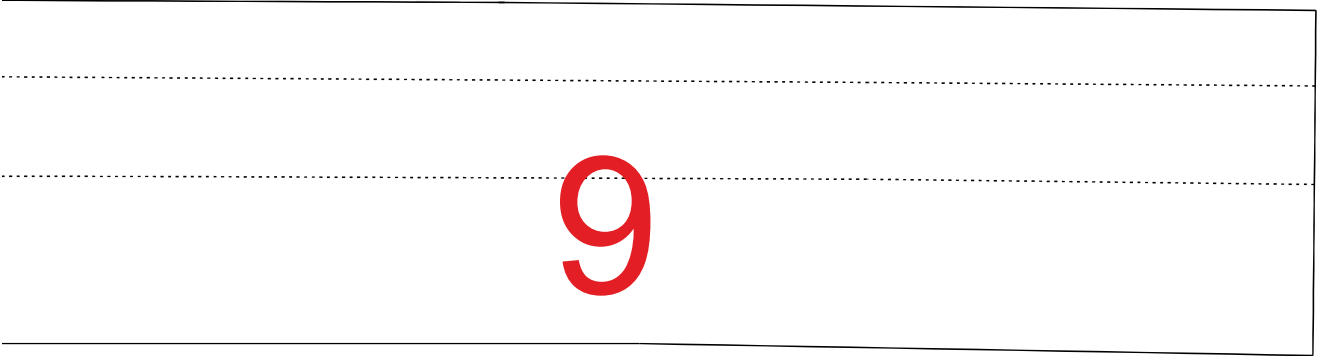

9





5

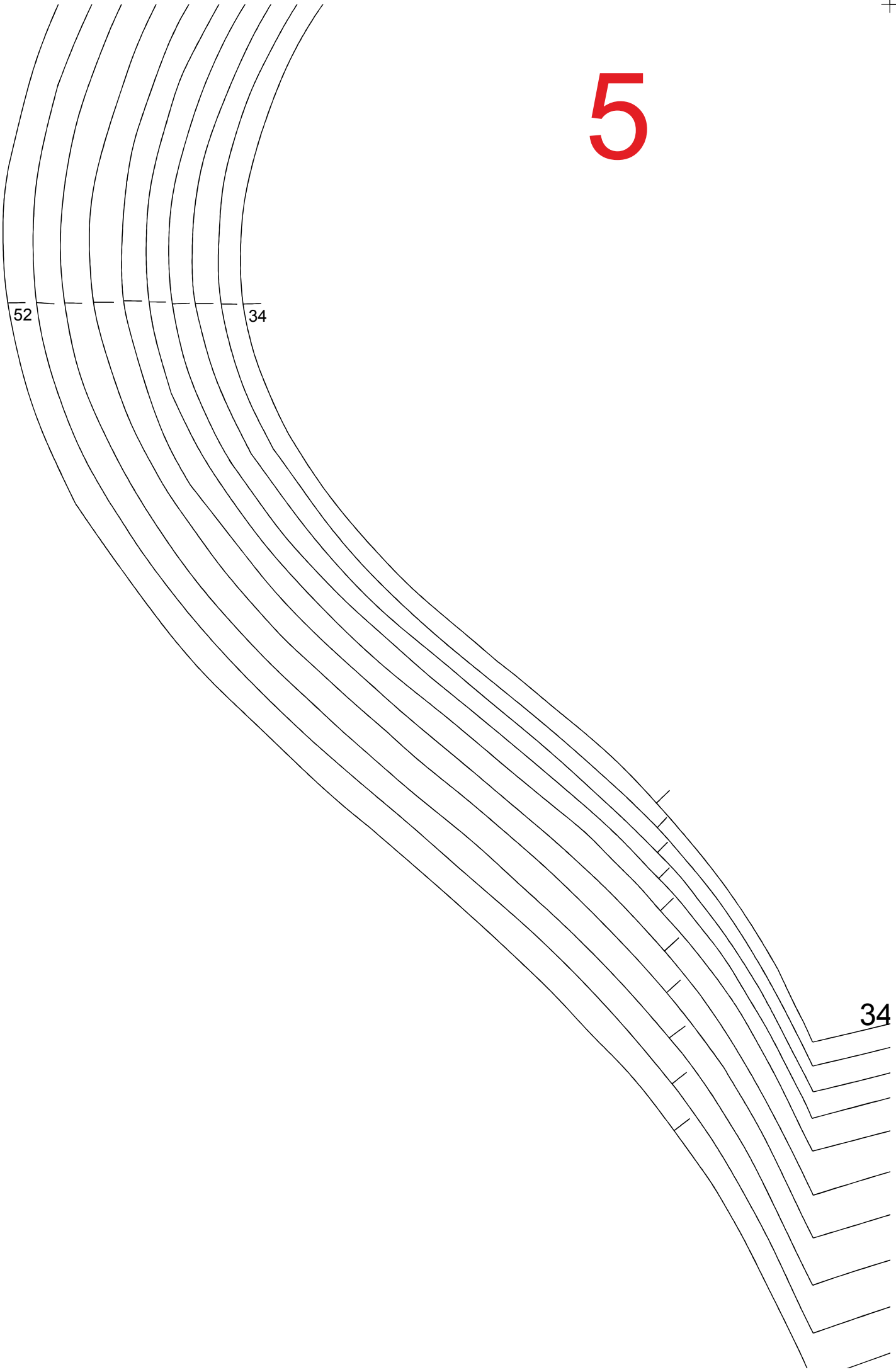

34



36  
38  
40  
42  
44  
46  
48  
50  
52

(3, 4)

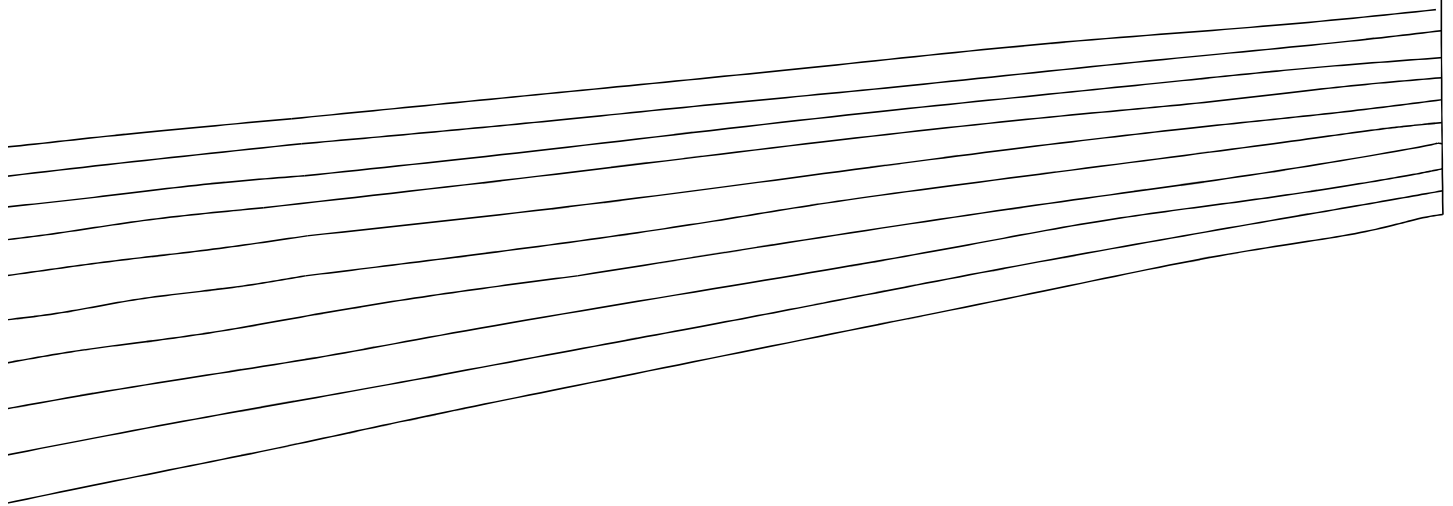
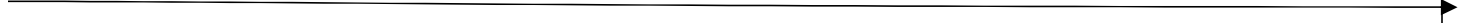

(4, 4)



34

36

38

40

42

44

46

48

50

52

6

52

34

34

36

38

40

42

44

46

48

50

52